

DETAIL OF MOUNTING BLOCK

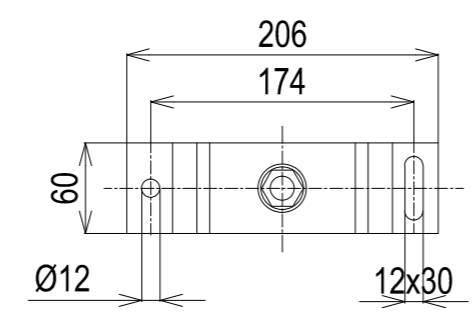

DIRECTION OF ROTATION

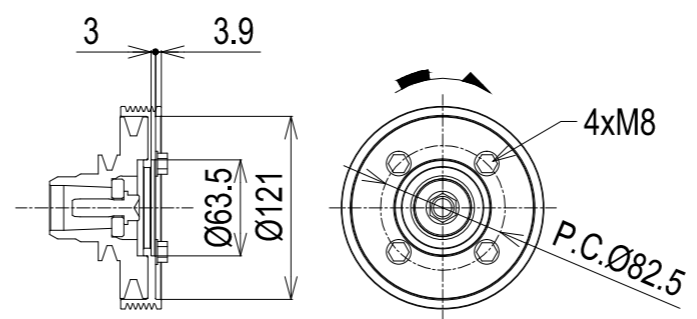

DETAIL OF PULLEY VIEWED FROM A

NOTE:

- 1.DWG.SHOWS MOUNTING BLOCKS AT ORIGINAL HEIGHT. ENGINE WEIGHT WILL COMPRESS BLOCKS BY 4.5 MM(APPROX).
- 2.MOUNTING BLOCKS ARE EQUIPPED FOR STANDARD ACCESSORY.
- 3.● SHOWS THE CENTER OF GRAVITY.
- 4.FOR ADDITIONAL INSTALLATION INFORMATION AND SPECIFICATIONS PLEASE REFER TO THE YANMAR ENGINE INSTALLATION MANUAL

Engine:	3YM20C_SD20	Release:	9-11-2012
Scale:	1:10	Date:	01-06-2013
		Dimensions:	mm